

BLUM METABOX & TANDEMBOX DRAWER SYSTEM

The BLUM METABOX & TANDEMBOX Systems are an entirely new concept for the functional and formal design of drawers, pull-out shelves and drawer organizers. The METABOX & TANDEMBOX Systems enables a manufacturer to combine the design aspect of the exterior with the interior of the cabinet. The METABOX & TANDEMBOX are a complete drawer system, the key element being a metal drawer side with an integrated slide mechanism, based on a single basic cabinet profile for all pull-out functions. This enables the manufacturer to fully automate cabinet production and only cut drawer bottoms, backs and fronts. The high quality BLUM METABOX & TANDEMBOX Systems offer rapid assembly, total system flexibility and contemporary design. 100 lbs. load capacity.

Drawer configurations

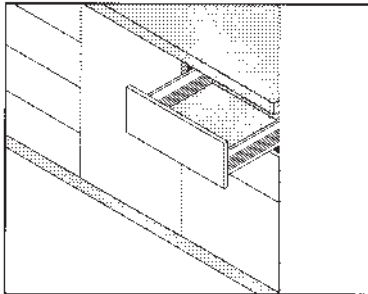

Standard drawer

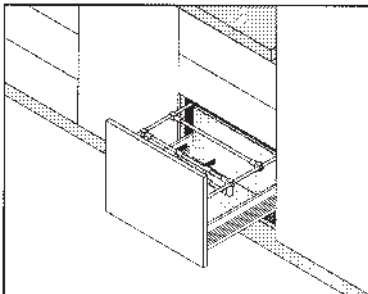

Standard drawer with gallery organization

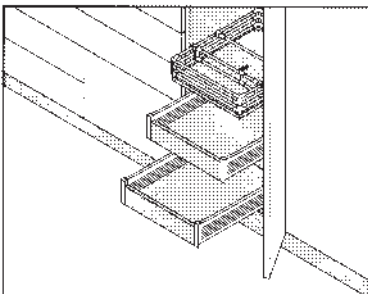

Gallery roll-out shelf (top)
Interior roll-out trays (bottom)

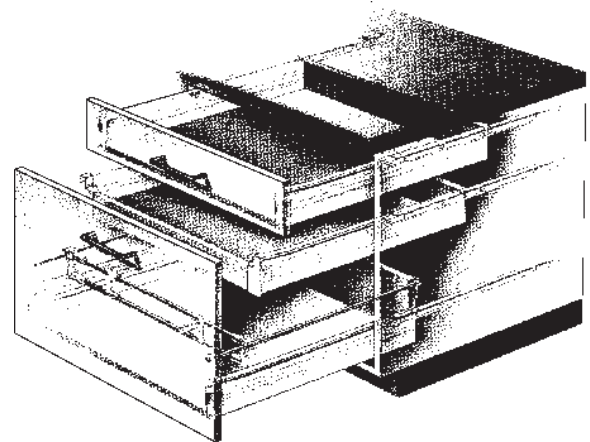

Testing standards at Blum

METABOX & TANDEMBOX complies with and exceeds the ANSI/BHMA 156.9-1994 standards, for a Grade 1 rating. Blum also performs other specific tests.

Dynamic wear test

100,000 open/close cycles with a total drawer weight of 34 kg (75 lbs)

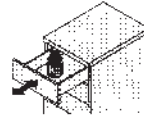

Static loading test

45.3 kg (100 lbs) applied to a half extended drawer for 1 minute

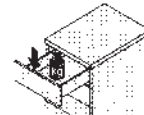

Side pressure test

A force of 15kg (6.8lbs) is applied ten times to a fully extended drawer

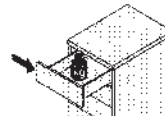

Global Benefits

Thank you for using Blum METABOX. We are sure you will find this a comprehensive drawer program that offers benefits for all users from the manufacturer to the consumer.



Julius Blum, Inc. is ISO 9001 certified which means you are assured of consistent quality in every Blum hardware product. As with all Blum hardware, METABOX is backed with a lifetime guarantee. Contact your Blum representative for full warranty details.

Index:

- DS-2 Diagrams of steel-sided METABOX and component list.
- DS-3 Diagrams of METABOX gallery rail, METAFILE and component list.
- DS-4 TANDEMBOX and component list.
- DS-5 TANDEMBOX and component list.
- DS-6 ORGA-LINE for TANDEMBOX.
- DS-7 ORGA-LINE for TANDEM drawers.

CabinetWare®

www.cabinetware.com

Sarasota
1-800-226-6300

Jacksonville
1-866-855-1575

Orlando
1-888-575-1500

Tampa
1-800-257-1855

BLUM METABOX 320 & 330

METABOX runner set: L & R cabinet & drawer profiles. Suffix "C15" for quick fix version	
1 & 2	Narrow side (54mm) - 3/4 extension Drawer length Part # 270mm (11") DSB-320N2700C.W 350mm (14") DSB-320N3500C.W 400mm (16") DSB-320N4000C.W 450mm (18") DSB-320N4500C.W 500mm (20") DSB-320N5000C.W 550mm (22") DSB-320N5500C.W
	Medium side (86mm) - 3/4 extension Drawer length Part # 270mm (11") DSB-320M2700C.W 350mm (14") DSB-320M3500C.W 400mm (16") DSB-320M4000C.W 450mm (18") DSB-320M4500C.W 500mm (20") DSB-320M5000C.W 550mm (22") DSB-320M5500C.W
	Med/High (118mm) - 3/4 extension Drawer length Part # 350mm (14") DSB-320K3500C.W 400mm (16") DSB-320K4000C.W 450mm (18") DSB-320K4500C.W 500mm (20") DSB-320K5000C.W 550mm (22") DSB-320K5500C.W
	High side (150mm) - 3/4 extension Drawer length Part # 350mm (14") DSB-320H3500C.W 400mm (16") DSB-320H4000C.W 450mm (18") DSB-320H4500C.W 500mm (20") DSB-320H5000C.W 550mm (22") DSB-320H5500C.W
	Medium side (86mm)- Full extension Drawer length Part # 400mm (16") DSB-330M4000C.W 450mm (18") DSB-330M4500C.W 500mm (20") DSB-330M5000C.W 550mm (22") DSB-330M5500C.W
	High side (150mm) - Full extension Drawer length Part # 400mm (16") DSB-330H4000C.W 450mm (18") DSB-330H4500C.W 500mm (20") DSB-330H5000C.W

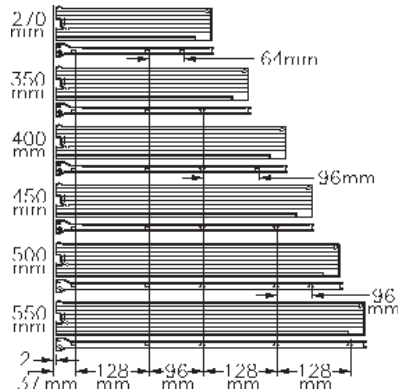
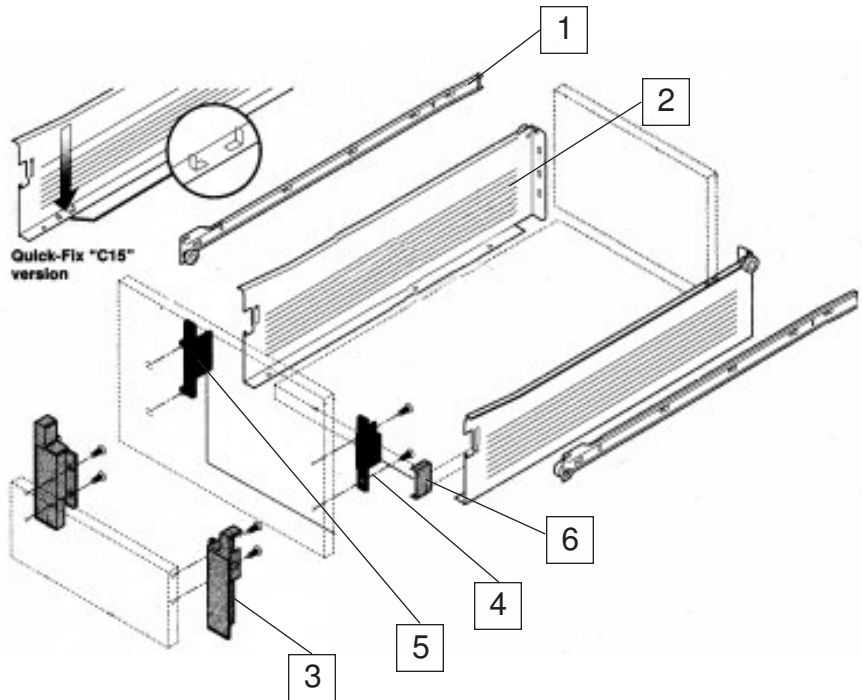

METABOX BRACKETS & COVER CAPS

3	Front fixing bracket for interior drawer. Screw-on Drawer type Part # N series DSB-ZIF.3010.W(L or R) M series DSB-ZIF.3000.W(L or R) K series DSB-ZIF.3030.W(L or R) H series DSB-ZIF.3050.W(L or R)	4	Screw-on front fixing bracket Drawer type Part # M/H Series DSB-ZSF.1700. (L or R)	
	5		Press-in front fixing bracket Drawer type Part # M/H series DSB-ZSF.1800. (L or R)	
		4	Screw-on front fixing bracket Drawer type Part # N series DSB-ZSF.1510.(L or R)	6
	5		Press-in front fixing bracket Drawer type Part # N series DSB-ZSF.1610.(L or R)	

Reference to length in inches is nominal. Cream components available by Special Order only.

7	<i>Adjustable gallery rod, front fixing sockets & rear fixing brackets.</i>	
	<i>Length</i>	<i>Part #</i>
	18" (450mm)	DSB-ZRE.421S.ID.W
	20" (500mm)	DSB-ZRE.471S.ID.W
	22" (550mm)	DSB-ZRE.521S.ID.W

BLUM METABOX GALLERY RAIL COMPONENTS

8	<i>Gallery rod</i>	
	<i>Length</i>	<i>Part #</i>
	39-3/8" (1000mm)	DSB-ZRG.1094U.CR (chrome) DSB-ZRG.1104U.W (white)

9	<i>Single rod cross support</i>	
	<i>Part #</i>	
	DSB-ZRU.00E0.W (white) DSB-ZRU.00E0.R737 (grey)	

10	<i>Double rod cross support</i>	
	<i>Part #</i>	
	DSB-ZRU.00Z0.W (white) DSB-ZRU.00Z0.R737 (grey)	

11	<i>Double rod cross divider</i>	
	<i>Part #</i>	
	DSB-ZRU.00F0.W (white) DSB-ZRU.00F0.R737 (grey)	

12	<i>Double corner support</i>	
	<i>Part #</i>	
	DSB-ZTU.00Z0.W (white) DSB-ZTU.00Z0.R906 (grey)	

13	<i>Triple corner support</i>	
	<i>Part #</i>	
	DSB-ZTU.00D0.W	

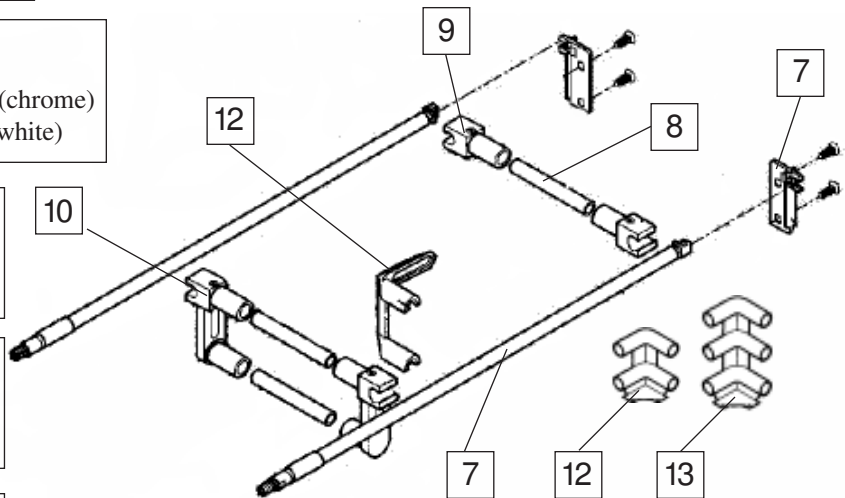

CabinetWare

BLUM METAFILE Hanging File Accessory

METAFILE Set	
Includes components listed below to make one standard hanging file.	
DSB-ZRM.5500.US.W	
14	<i>2-Steel hanging rails</i> 3 x 13 x 1100, cut to length DSB-ZRM.1100S.ZN
	<i>4-Rail support brackets</i> <i>Part #</i> DSB-ZRM.0005
15	<i>4-Rail support covers</i> <i>Part #</i> DSB-ZRM.0003.W
	<i>2-Glide Profiles</i> 1100mm long, cut to length. DSB-ZRM.1100G.W

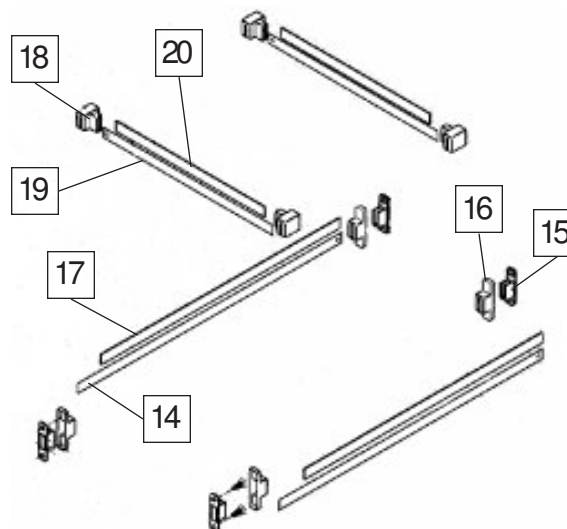

Lateral File Accessories

18	<i>Lateral bracket</i> 4 required per drawer DSB-ZRM.0004.W
	<i>Steel hanging rail</i> 3 x 13 x 1100mm DSB-ZRM.1100S
20	<i>Glide Profile</i> 1100mm long DSB-ZRM.1100G

Please note - Some products featured in this catalog may not be stock items. See CabinetWare.com for current stock availability.

CABINET PROFILES



Cabinet profiles 558 and 559 packaged in pairs (L/R)

75 lb

- DSB-558.2701A 270mm (12")
- DSB-558.3501A 350mm (14")
- DSB-558.4001A 400mm (16")
- DSB-558.4501A 450mm (18")
- DSB-558.5001A 500mm (20")
- DSB-558.5501A 550mm (22")

110 lb

- DSB-559.4501A 450mm (18")
- DSB-559.5001A 500mm (20")
- DSB-559.5501A 550mm (22")

Same as above with Blumotion integrated into slide.

75 lb

- DSB-558.2701B 270mm (12")
- DSB-558.3501B 350mm (14")
- DSB-558.4001B 400mm (16")
- DSB-558.4501B 450mm (18")
- DSB-558.5001B 500mm (20")
- DSB-558.5501B 550mm (22")

110 lb

- DSB-559.4501B 450mm (18")
- DSB-559.5001B 500mm (20")
- DSB-559.5501B 550mm (22")

CabinetWare

FRONT FIXING BRACKETS



Front fixing brackets sold each. Non handed. Need 2 per Tandembox pair.
DSB-ZSF.3902 Zinc

CabinetWare

CROSS GALLERY ROD



Single gallery rod for front. 1094mm.
DSB-ZRG.1094U.CR Chrome
DSB-ZRG.1094U.R906 Gray

BLUM TANDEMBOX DRAWER PROFILES



Drawer profiles 358M packaged in pairs (L/R), including cover caps.

Inox (Stainless Steel)

- DSB-358M2702I 270mm (12")
- DSB-358M3502I 350mm (14")
- DSB-358M4002I 400mm (16")
- DSB-358M4502I 450mm (18")
- DSB-358M5002I 500mm (20")
- DSB-358M5502I 550mm (22")

Gray

- DSB-358M2702S 270mm (12")
- DSB-358M3502S 350mm (14")
- DSB-358M4002S 400mm (16")
- DSB-358M4502S 450mm (18")
- DSB-358M5002S 500mm (20")
- DSB-358M5502S 550mm (22")

CabinetWare

INTERIOR DRAWER BRACKETS

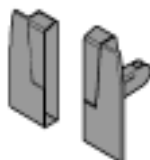

Interior fixing brackets. Packaged in pairs (L/H). Grey finish.

For M height drawers
DSB-ZIF.70M0

For M height drawers with single gallery rail.
DSB-ZIF.72BO

For M height drawers with gallery rail and boxside.
DSB-ZIF.73DO.R737

CabinetWare

FRONT RAIL

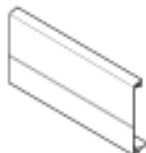

Front piece for interior drawers.
DSB-Z31A1081A.W White
DSB-Z31A1081A.R906 Gray

REAR FIXING BRACKETS

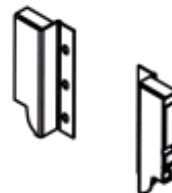

Rear fixing brackets packaged in pairs. (L/R). For M height drawer.

DSB-Z30M000S.04.NI Nickel
DSB-Z30M000S.04.R906 Gray

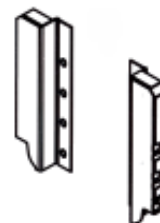

Rear fixing brackets packaged in pairs. (L/R). For M height drawer with a single gallery.

DSB-Z30B000S.04.NI Nickel
DSB-Z30B000S.04.R906 Gray



Rear fixing brackets packaged in pairs. (L/R). For double gallery or double wall boxside.

DSB-Z30D000S.04 Nickel
DSB-Z30D000S.04.R906 Gray

CabinetWare

HANDLE

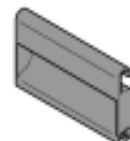

Handle for interior drawer.
DSB-ZIF.7008.R737 Gray

M BOXSIDE

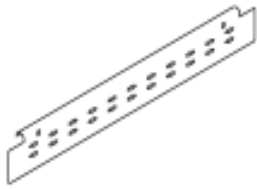

M height single wall BOXSIDE. 2-1/2" high. Non-handed, need two per drawer.

Nickel

DSB-Z36M417SE01.NI 450mm (18")
DSB-Z36M467SE01.NI 500mm (20")
DSB-Z36M517SE01.NI 550mm (22")

Gray

DSB-Z36M417SE01.R906 450mm
DSB-Z36M467SE01.R906 500mm
DSB-Z36M517SE01.R906 550mm

CabinetWare

H BOXSIDE

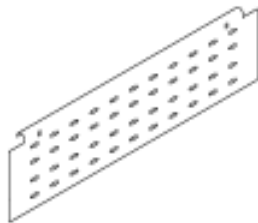

H height BOXSIDE. 5" high. Non-handed, need two per drawer.

Nickel

DSB-Z36H417SE01.NI 450mm (18")
DSB-Z36H467SE01.NI 500mm (20")
DSB-Z36H517SE01.NI 550mm (22")

Gray

DSB-Z36H417SE01.R906 450mm
DSB-Z36H467SE01.R906 500mm
DSB-Z36H517SE01.R906 550mm

BLUM TANDEMBOX DOUBLE WALL

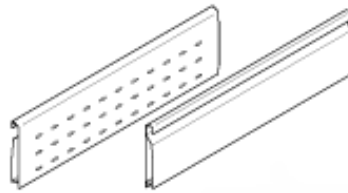

Double-wall BOXSIDE (left & right).

Stainless Steel

DSB-Z37H418L.E 450mm (18")
DSB-Z37H468L.E 500mm (20")
DSB-Z37H518L.E 550mm (22")

Gray

DSB-Z37H418S.E 450mm (18")
DSB-Z37H468S.E 500mm (20")
DSB-Z37H518S.E 550mm (22")

CabinetWare

GALLERY RAILS



Gallery rods. Sold in sets (left & right)

Chrome

DSB-ZRG296V.IC.CR 350mm (14")
DSB-ZRG346V.IC.CR 400mm (16")
DSB-ZRG396V.IC.CR 450mm (18")
DSB-ZRG446V.IC.CR 500mm (20")
DSB-ZRG496V.IC.CR 550mm (22")

Gray

DSB-ZRG.296V.IC.R906 350mm
DSB-ZRG.346V.IC.R906 400mm
DSB-ZRG.396V.IC.R906 450mm
DSB-ZRG.446V.IC.R906 500mm
DSB-ZRG.496V.IC.R906 550mm

BOXSIDE DIVIDER SET



Orga-Line Rail Divider Set for 600mm cabinet width.

DSB-ZRI.60B006.CR Chrome
DSB-ZRI.60B006.R906 Gray

Orga-Line Rail Divider Set for 1200mm cabinet width.

DSB-ZRI.12B006.CR Chrome
DSB-ZRI.12B006.R906 Gray

CabinetWare

BLUMOTION



BLUMOTION - a unique system for smooth and silent closing. BLUMOTION engages when the drawer is closing and applies resistance to the self-closing mechanism. The result is a controlled soft close.

DSB-Z70.31E0.02

For more Tandembox and Orgaline products see your Blum Catalog.
Call your CabinetWare sales representative today for your copy!



CabinetWare®

www.cabinetware.com

Sarasota
1-800-226-6300

Jacksonville
1-866-855-1575

Orlando
1-888-575-1500

Tampa
1-800-257-1855

Please note - Some products featured in this catalog may not be stock items. See CabinetWare.com for current stock availability.

BLUM ORGA-LINE for TANDEMBOX

TANDEMBOX with ORGA-LINE means total access.

Blum ORGA-LINE brings beautiful form and function to the interior of TANDEMBOX drawers. At the core of ORGA-LINE are stainless steel cutlery trays that can be arranged in a multitude of ways. Easily removed for cleaning (dishwasher safe) or taking silverware to the table. The companion utensil dividers can stand alone in drawer or can be coupled to the cutlery trays. Adjustable spring loaded dividers lock into the stainless steel rails offer yet another custom fit.

ORGA-LINE drawer dividing system - 500mm (20") drawer length.

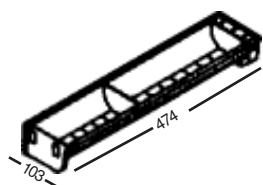

DSB-ZSI.500BI1

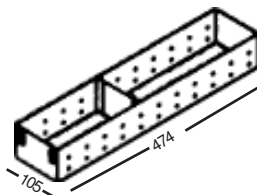

DSB-ZSI.500FI1

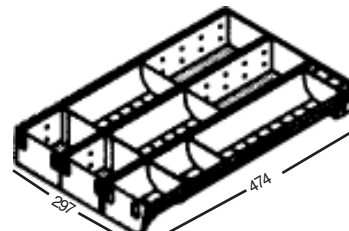

DSB-ZSI.500MI3

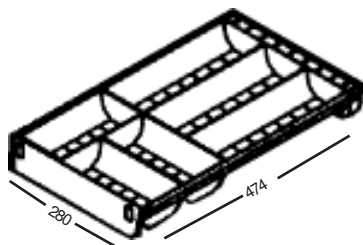

DSB-ZSI.500BI3

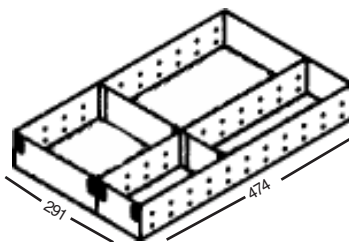

DSB-ZSI.500FI3

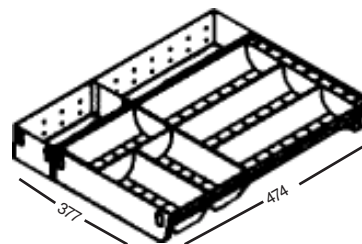

DSB-ZSI.500KI4A

ORGA-LINE drawer dividing system - 550mm (22") drawer length.

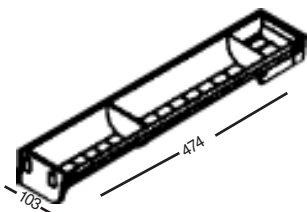

DSB-ZSI.550BI1

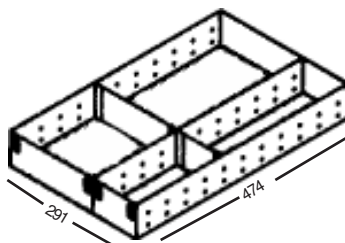

DSB-ZSI.550FI3

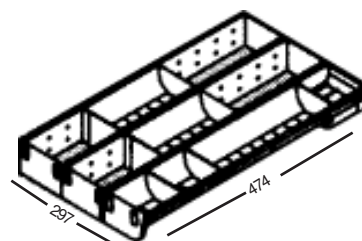

DSB-ZSI.550MI3

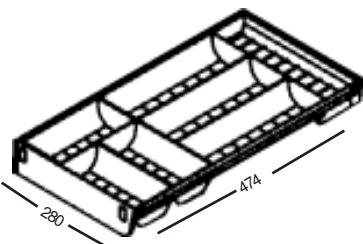

DSB-ZSI.550BI3A

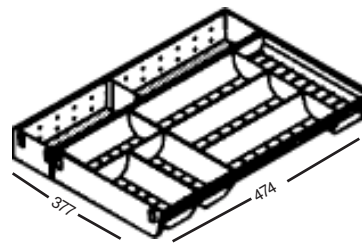

DSB-ZSI.550KI4A

BLUM ORGA-LINE for TANDEM DRAWERS

Blum ORGA-LINE for TANDEM drawers is a program of insert kits that fit into wood drawers that are built to the dimension standards of Blum's TANDEM concealed drawer runners. (see page SL-6 & SL-7) Dishwasher safe, stainless steel trays, adjustable partitions that custom tailor utensil divider kits, spring loaded side rails and compensation trays allow for a great fit and function in any situation.

Cutlery Kits for 21" Drawer Lengths

Inside drawer length: 19 1/4" - 20"



DSB-ZHI.533BI1A



DSB-ZHI.533BI3A



DSB-ZHI.533KI4A



DSB-ZHI.533TI4A

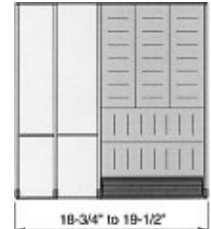

DSB-ZHI.533TI5A

Utensil Kits for 21" Drawer Lengths

Inside drawer length: 19 1/4" - 20"



DSB-ZHI.533FI1A



DSB-ZHI.533FI3A

Combination Kits for 21" Drawer Lengths

Inside drawer length: 19 1/4" - 20"



DSB-ZHI.533MI3A

CabinetWare

Utensil Kits for 18" Drawer Lengths

Inside drawer length: 19 1/4" - 20"



DSB-ZHI.457FI1A

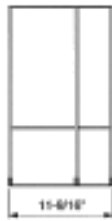

DSB-ZHI.457FI3A

Combination Kits for 18" Drawer Lengths

Inside drawer length: 19 1/4" - 20"

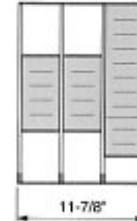

DSB-ZHI.457GI3A

CabinetWare

ORGA-LINE Plate Holder.

A new idea for organizing the kitchen

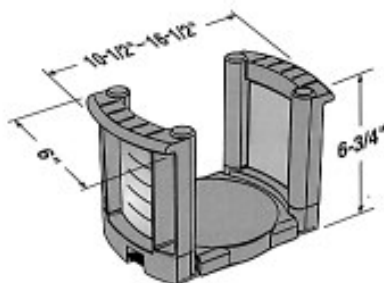
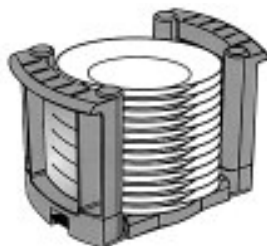

The ORGA-LINE plate holder makes organizing stacks of plates quick and easy. Adjusts to fit most common dinner plates. Rubber feet hold the plate holder in place. Designed to make storing and accessing plates simple by placing them in a drawer instead of an overhead cupboard. The handles make carrying plates to the dinner table or patio a breeze.

DSB-ZTH.0350

CabinetWare®

www.cabinetware.com

Sarasota
1-800-226-6300

Jacksonville
1-866-855-1575

Orlando
1-888-575-1500

Tampa
1-800-257-1855

INDEX CARD FILE FOLLOWER

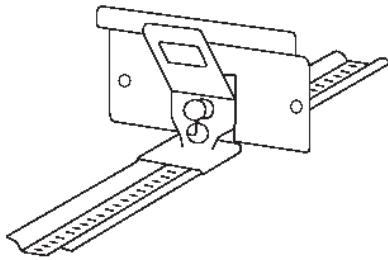

Shown with track(sold separately). Mounted plate stands 2-11/16" above track surface x 4-3/4" wide. Zinc with anochrome finish.
FAK-475FZC

CabinetWare

LETTER SIZE FILE FOLLOWER

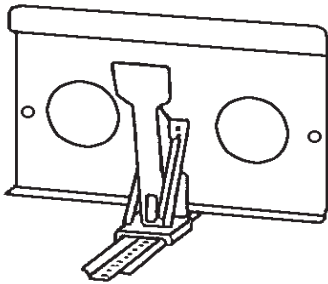

Shown with track(sold separately). Mounted plate stands 7-5/8" above track surface x 10-3/4" wide. Zinc with anochrome finish.
FAK-476FZC

CabinetWare

FILE FOLLOWER TRACK

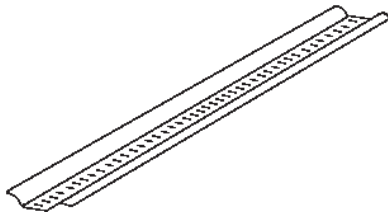

26" long. May be recessed in 1-3/4" x 1/4" slot for FAK-475FZC index card follower or 2-1/4" x 1/4" slot for FAK-476FZC letter size follower. Anochrome finish.
FAK-476TZC

HANGING FILE BRACKET / BAR

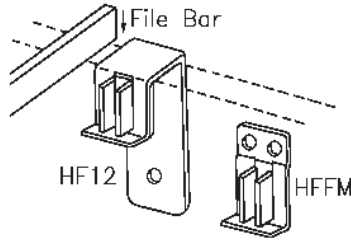

Steel bracket. Use side/side or front/back for letter or legal files.

FH-HF12 Slide on to top.
FH-HFFM Screw on to side.

1/2" x 1/8" x 43-1/4" steel bar.
DSB-ZRM.1100S.ZN

White bar cover.
DSB-ZRM.1100G.W

1/2" x 1/8" x 10' aluminum bar.
FH-HF1210

CabinetWare

HANGING FILE STRIP

Tough black plastic. Use on the top of 1/2" thick drawers

98" long black plastic strip.
FH-HF1298

CabinetWare

HANGING FILE BAR



1" x 1/8" x 10' aluminum bar. Screw to side of drawer for pendaflex file folders.

FH-HF110

NOTES

JEWELRY TRAY DRAWER LINERS

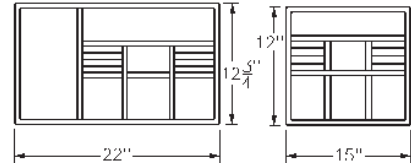

Blue nylon velvet covered jewelry tray with padded ring bars. Scratch free. Snag free.

Small jewelry tray.
FH-JT15

Large jewelry tray.
FH-JT22

CabinetWare

SILVER DRAWER LINING KIT

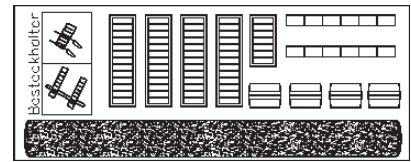

Complete kit for a 70 piece silver set including roll of felt for bottom of drawer 100cm x 45cm (approx. 39-3/8" x 17-23/32"). All parts self-adhesive. Brown color.

FH-SDL700BN

Self-stick brown felt roll. 18"x40"
FH-SDL1840BN

CabinetWare



- Color pictures
- Secure Online Ordering
- Real Time Inventory
- 24 / 7 / 365
- Account Status

Call for your password today!